

TAIDEN®

High Definition Digital Video Tracking Matrix Switcher

Professional Matrix Switchers



Installation and Operation Manual

V 1.1

Remark:

- All rights reserved for translation, reprint or reproduction
- Contents may change without prior announcement
- All technical specifications are guideline data and not guaranteed features
- Taiden Co., Ltd. is not responsible for any damage caused by improper use of this manual
- The equipment must be connected to earth!
- This product conforms to the rules of the European directive 2004/108/EC.
- If any detailed information needed, please contact your local agent or TAIDEN service center in your region.
Any feedback, advice and suggestion about the products is appreciated
- TAIDEN is the registered trademark of TAIDEN Co., Ltd.

Important Safety Instruction

1. Read and keep these instructions.
2. Heed all warnings and follow all instructions.
3. The apparatus shall not be exposed to dripping or splashing and that no objects filled with liquids, such as vases, shall be placed on the apparatus.
4. The MAINS plug serving as a disconnection device, should be easy to operate.
5. The apparatus should be connected to the MAINS socket-outlet with protective earth.
6. Clean only with dry cloth.
7. Do not block any ventilation openings. Install in accordance with the manufacturer's instructions.
8. Do not install near any heat sources such as radiators, heat registers, stoves, or other apparatus (including amplifiers) that produce heat.
9. Do not defeat the safety purpose of the polarized or grounding-type plug. A polarized plug has two blades with one wider than the other. A grounding type plug has two blades and a third grounding prong. The wide blade and the third prong are provided for your safety. If the provided plug does not fit into your outlet, consult an electrician for replacement of the obsolete outlet.
10. Protect the power cord from being walked on or pinched particularly at plugs, convenience receptacles, and the point where they exit from the apparatus.
11. Only use attachments/accessories specified by the manufacturer.
12. Use only with the cart, stand, tripod, bracket, or table specified by the manufacturer, or sold with the apparatus. When a cart is used, use caution when moving the cart/apparatus combination to avoid injury from tip-over.
13. Unplug this apparatus during lightning storms or when unused for long periods of time.
14. Refer all servicing to qualified service personnel. Servicing is required when the apparatus has been damaged in any way, such as power-supply cord or plug is damaged, liquid has been spilled or objects have fallen into the apparatus, the apparatus has been exposed to rain or moisture, does not operate normally, or has been dropped.
15. Do not place the equipment on any uneven or unstable stand; original product package or appropriate package should be used to avoid damage caused by strong impacts during transportation.
16. Power supply cords:
AC 100 V-120 V 60 Hz or AC 220 V-240 V 50 Hz
17. The quantity of connected units in one system should not exceed prescribed quantity. For service, please contact the nearest TAIDEN Service Center.
18. Use ONLY specified connection cable to connect the system equipment.
19. All TAIDEN products are guaranteed for definite time (see the WARRANTY CARD for details) excluding the following cases:
 - A. All damage or malfunction caused by human negligence;
 - B. Damage or malfunction caused by improper operating by operator;
 - C. Parts damage or loss caused by disassembling the product by non-authorized personnel.
20. Upon receipt of the product, please fill out the Warranty Card enclosed and post it to TAIDEN Service Center nearby in your region.



TO REDUCE THE RISK OF ELECTRIC SHOCK, DO NOT EXPOSE THIS EQUIPMENT TO RAIN OR MOISTURE.

CAUTION: To reduce the risk of electric shock, DO NOT open covers, no user serviceable parts inside. Refer servicing to qualified service personnel only.

CAUTION: DO NOT use alcohol, ammonia or petroleum solvents or abrasive cleaners to clean the devices.



The lightning flash with an arrowhead symbol, with an equilateral triangle, is intended to alert the user to the presence of uninsulated 'dangerous voltage' within the products enclosure that may be of sufficient magnitude to constitute a risk of electric shock to persons.

Important Safety Instruction



The exclamation mark within an equilateral triangle is intended to alert the user to the presence of important operating and maintenance (servicing) instructions in the literature accompanying the appliance.

WARNING: To reduce the risk of fire or electric shock, DO NOT expose units to rain or moisture.



Attention: Installation should be performed by qualified service personnel only in accordance with the National Electrical or applicable local codes.



Power Disconnect: Units with or without ON – OFF switch have power supplied to the unit whenever the power cord is inserted into the power source; however, the unit is operational only when the ON – OFF switch is in the ON position. The power cord is the main power disconnect for all units

WARNING: The apparatus should be connected to a mains socket outlet with a protective earthing connection.

Contents

Installation & User Guide.....	V
Chapter 1. High Definition Digital Video Tracking Matrix Switchers.....	1
1.1 Functions and indications	1
1.2 Installation and connection	2
1.2.1 Installation	2
1.2.2 Connection between Mixed Switcher and PC.....	2
1.2.3 Connection with input, output devices	2
1.3 Setup and Operation.....	4
1.3.1 Menu setup	4
1.3.2 Switch operation.....	7
Chapter 2. IR Remote Control.....	10
Chapter 3. Communication protocol and control code.....	11
Chapter 4. Technical data.....	13

Installation & User Guide

About this manual

This manual is a comprehensive guide to the installation and operation of TAIDEN SDI Series High Definition Digital Video Tracking Matrix Switchers. It includes: connection and operation, protocol and control code, etc.

The manual is divided into the following chapters:

Chapter 1: High Definition Digital Video Tracking Matrix Switchers

Descriptions in detail of the functions and indications, installation and connection, configuration and operation of High Definition Digital Video Tracking Matrix Switchers.

Chapter 2: IR Remote Control

Introduction into the operation of IR remote control.

Chapter 3: Communication protocol and control code

Detailed description of codes and their function.

Chapter 4: Technical data

Mechanical and electrical details of the High Definition Digital Video Tracking Matrix Switchers.

This manual is applicable to:

TMX-0404SDI

4×4 High Definition Digital Video Tracking Matrix Switcher (SD/HD/3G)

TMX-0804SDI

4×4 High Definition Digital Video Tracking Matrix Switcher (SD/HD/3G)

TMX-0808SDI

4×4 High Definition Digital Video Tracking Matrix Switcher (SD/HD/3G)

Chapter 1. High Definition Digital Video Tracking Matrix Switchers

1.1 Functions and indications

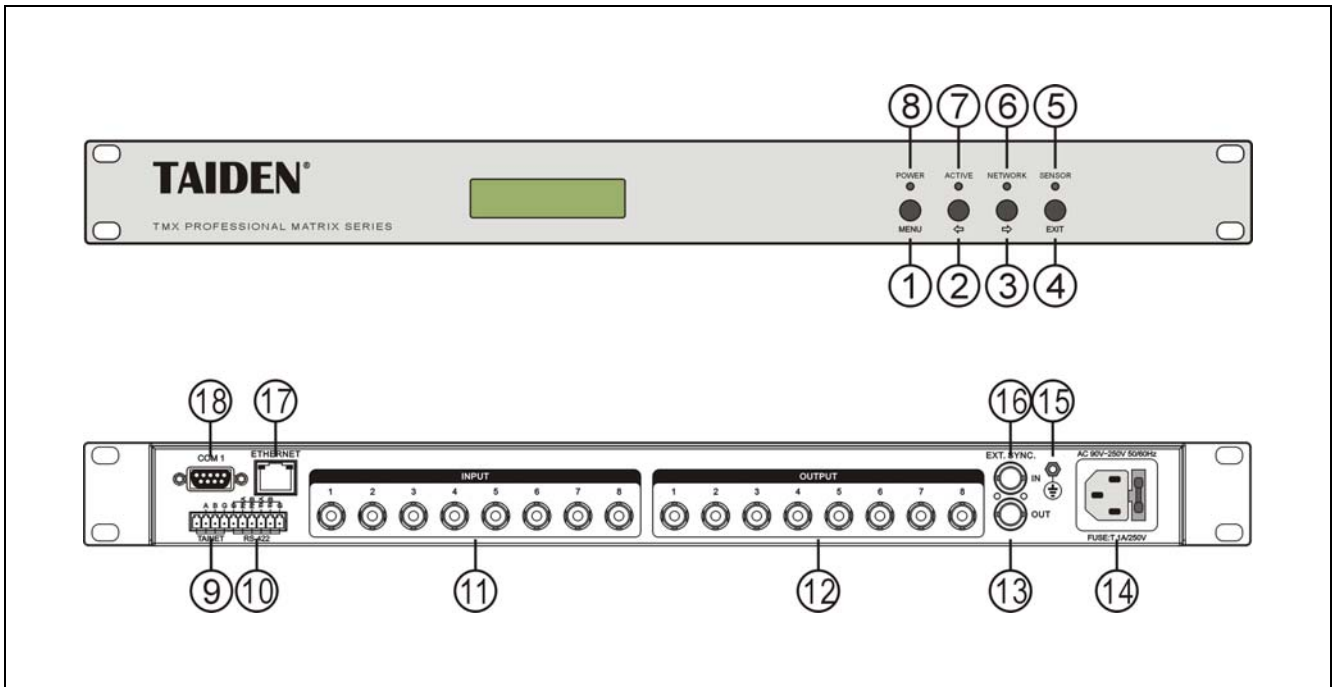

Figure 1.1 Panels of SDI Matrix Switcher

Front panel:

1. **“MENU” button**
 - a) If in current state, press “MENU” go to main menu;
 - b) If in menu state, press “MENU” go to sub menu;
 - c) Select/Deselect in network configuration.
2. **“←” (Left) button**
3. **“→” (Right) button**
4. **“Exit” button**
 - ◆ Return to previous directory or root.
5. **IR receiving window**
 - ◆ Receives the IR signals from remote control; make sure the remote control aims at the window.
6. **“NETWORK” indicator**
 - ◆ Indicator flashes if Matrix Switcher is connected with PC software.
7. **“ACTIVE” indicator**
 - ◆ Indicator will be turned on if Matrix Switcher executes switch instructions.
8. **“POWER” indicator**

Rear panel:

9. **TAINET interface**
10. **RS-422/485 interface**
11. **Video inputs**
12. **Video outputs**
13. **CVBS output / synchronized loop out**
14. **Power cable interface**
15. **Grounding point**
16. **CVBS input / synchronized input**
17. **RJ45 interface**
18. **RS-232 communication interface COM1**

1.2 Installation and connection

1.2.1 Installation

1U High Definition Digital Video Tracking Matrix Switcher just needs to put it into the cabinet, and fix it by screws. As figure 1.3.

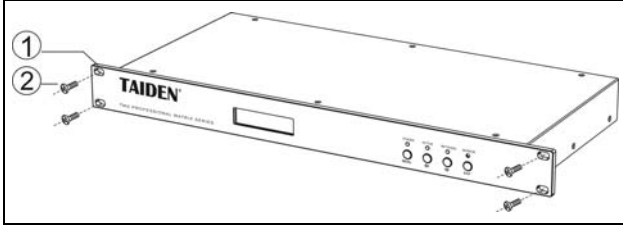

Figure 1.3 Installation

1.2.2 Connection between Mixed Switcher and PC

High Definition Digital Video Tracking Matrix Switcher can be controlled by Central Control System via RS-232 interface COM1, this interface is also used for software upgrade. As figure 1.4.

1.2.3 Connection with input, output devices

High Definition Digital Video Tracking Matrix Switcher supports various digital video signal sources, including: full HD (3G), HD and SD. As figure 1.4.

Please use good quality Twisted Pair cable to connect input and output device, i.e. RG59 and RG60.

Control Interface:

Video Track Off	
COM (RS-232)	9 pin female D connector
COM1	Baud rate: 9600, data: 8 bits, stop: 1 bit, no parity check bit
RJ45	To matrix PC software
RS422/RS485, TAINET	Invalidation
Video Track On	
COM (RS-232)	9 pin female D connector
COM1	Baud rate: 9600, data: 8 bits, stop: 1 bit, no parity check bit
RJ45	Invalidation
TAINET	Baud rate: 19200, to TO VIDEO SWITCHER of main unit
RS422/RS485	Baud rate: 9600, to doom camera

Note:

☞ If connected with camera by RS232 protocol, the matrix switcher and the camera must be common ground.

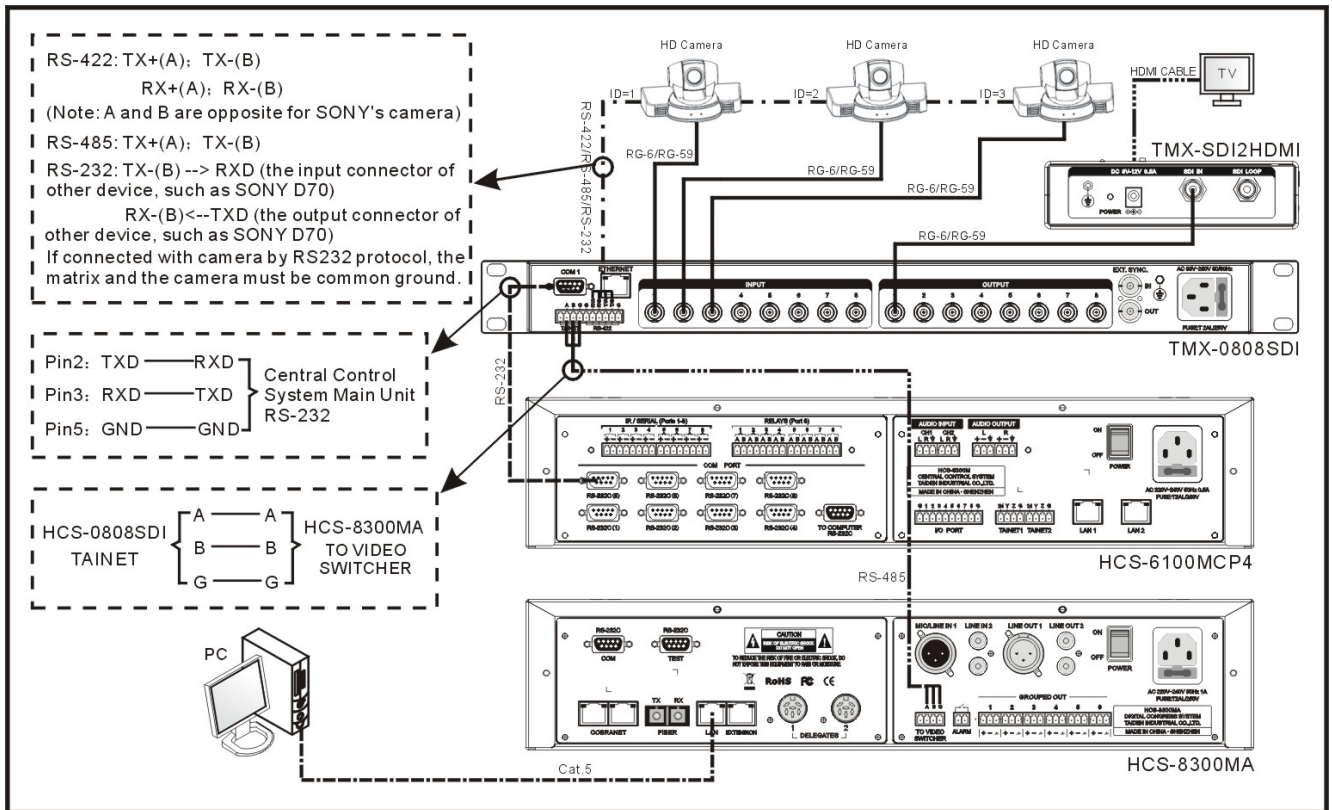

Figure 1.4 Connection example for input and output devices to TMX-0808SDI Matrix Switcher

1.3 Setup and Operation

1.3.1 Menu setup

1.3.1.1 Menu setup

To explain menu setup of SDI series Matrix Switcher, TMX-0808SDI serves as example.

TMX-0808SDI main interface:

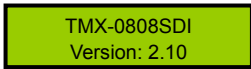

Press "MENU" to enter main menu and press "←/→" until "Setting" prompts; Press "MENU" again to enter setup menu, including:

- 1. Ring
- 2. COM2 Baud rate
- 3. Demo Switch Delay
- 4. COM1 protocol
- 5. Sync Switch Delay
- 6. Test button
- 7. Video Track
- 8. Video Track Type

Press "EXIT" to exit menu.

Note:

- ☞ When Video Tracking is off, RJ45 has TCP/IP function.
- ☞ When Video Tracking is on, RJ45 is Invalidation; camera protocol can be selected from Video Track Type menu; RS422/RS485 can be connected to control doom camera; TAINET can be connected to congress main unit.
- ☞ COM1 port can be connected to central control system.

Menu 1 to menu 8 are explained explicitly:

1. Ring

Buzzer ring on-off of this unit. If buzzer ring is setup "on", the buzzer will ring when front panel operation, PC software executing switch and receiving command from central control system. The buzzer ring can be setup "off".

- ON: open ;
- OFF: close.

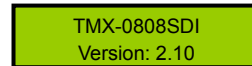

1. Press "MENU" to enter setup menu and press "←/→" until "Setting" prompts;



2. Press "MENU" and press "←/→" until "Ring" prompts;



3. Press "MENU" to enter setup;



4. Press "←/→" to select parameter;



5. Press "MENU" to confirm.



2. COM2 Baud rate

SDI series Matrix Switcher has no COM2 port, so this item can't be adjustable.

3. Demo Switch Delay

The interval ranges from 2 seconds to 60 seconds by steps of 2 seconds.

TMX-0808SDI
Version: 2.10

1. Press "MENU" and press "↔" until "Setting" prompts;

Setting

2. Press "MENU" and press "↔" until "Demo Switch Delay" prompts;

DemoSwitchDelay:
2 S

3. Press "MENU" to enter setup;

DemoSwitchDelay:
■ 2 *S

4. Press "↔" to adjust parameter;

DemoSwitchDelay:
■ 4 *S

5. Press "MENU" to confirm.

DemoSwitchDelay:
4 S

4. COM1 protocol

Central control system can be selected from Taiden, Extron or Other, Please add correct protocol according to user request.

TMX-0808SDI
Version: 2.10

1. Press "MENU" and press "↔" until "Setting" prompts;

Setting

2. Press "MENU" and press "↔" until "COM1 protocol" prompts;

COM1 protocol:
Taiden

3. Press "MENU" to enter setup;

COM1 protocol:
■ Taiden

4. Press "↔" to select parameter;

COM1 protocol:
■ Extron

5. Press "MENU" to confirm.

COM1 protocol:
Extron

5. Sync Switch Delay

This item can't be adjustable.

6. Test button

Tested button is working if character changes when button is pressed.

7. Video Track

Select the function of video track on or off.

TMX-0808SDI
Version: 2.10

1. Press "MENU" and press "↔" until "Setting" prompts;

Setting

2. Press "MENU" and press "↔" until "Video Track" prompts;

Video Track
OFF

3. Press "MENU" to enter setup;

Video Track
■ OFF

4. Press "↔" to adjust parameter;

Video Track
■ ON

5. Press "MENU" to confirm.

Video Track
ON

Note:

☞ The function of video track on will be enabled after rebooting the matrix switcher.

8. Video Track Type

When Video Track is on, camera protocol can be selected from HCS-3316RS232/ HCS-3316RS485/ SONY HD1/ PELCO D/ PELCO DC/ PELCO P1/ PELCO P2/ PANASONIC CS950/ PANASONIC HE100/ SAMSUNG C6407P/ HCS-3313C/ SONY D70/ SONY D100/ SONY BRC-Z330/ SONY BRC300/ SONY BRC700. Please select correct protocol according to actual device type.

TMX-0808SDI
Version: 2.10

1. Press "MENU" and press "↔" until "Setting" prompts;

Setting

2. Press "MENU" and press "↔" until "Video Track Type" prompts;

Video Track Type
PELCO P1

3. Press "MENU" to enter setup;

Video Track Type
■ PELCO P1

4. Press "↔" to select parameter;

Video Track Type
■ PELCO P2

5. Press "MENU" to confirm.

Video Track Type
PELCO P2

1.3.2 Switch operation

To explain menu operation of SDI series Matrix Switcher, TMX-0808SDI type serves as example. All SDI series Matrix Switcher can refer to it.

Note:

- ☞ “Input channel” and “output channel” number must be less than matrix type. For example: TMX-08xxSDI series can only input number 1-8.
- ☞ If any menu item is edited, except setup menu, a key must be pressed within 15 seconds otherwise the system will return to main menu item automatically and erase the previous channel setup.
- ☞ To return to main menu press any key if currently editing user interface is switch finish interface, display input, output status interface or DEMO interface. To return to main menu if editing other user interface press “EXIT” or “←”.

TMX-0808SDI main interface:

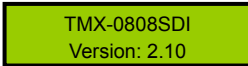

Press “MENU” to enter switch menu, including:

1. Switch Video

2. Switch through

* Switch through one channel or all channels.

3. Close

* Close one output or all outputs.

4. Save scene

5. Recall scene

6. Undo

* Undo last switch.

7. Demo Switch

* Switch one by one.

8. Setting

* Setup menu.

9. Status

* Request channel state.

Menu 1 to menu 9 are explained explicitly:

1. Switch Video

Video switch key, switches one input video signal to any or all output channels.

Example: Switch Video signal of input channel 1 to output channel 8

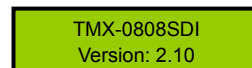

↓ 1. Press “MENU” to enter menu;

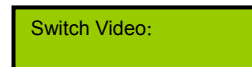

↓ 2. Press “MENU” to enter “Switch Video”;

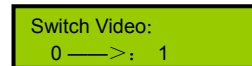

↓ 3. Press “MENU” to select input channel;
4. Press “←/→” to adjust input channel as “1”;

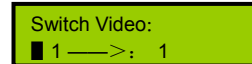

↓ 5. Press “MENU” to select output channel;
6. Press “←/→” to adjust output channel as “8”;



↓ 7. Press “MENU” to confirm and press “EXIT” twice.



Note:

- ☞ If input channel displays “0”, output channel is closed.
- ☞ If output channel displays “ALL”, input channel is switched to all output channels.

2. Switch through

Switch through one input channel or all input channels to corresponding output channel(s).

Example: Switch through channel 2.

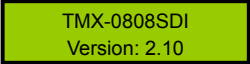

↓ 1. Press "MENU" and press "←/→" until "Switch through" prompts;

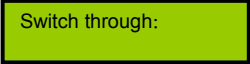

↓ 2. Press "MENU" to enter "Switch through";

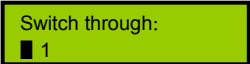

↓ 3. Press "←/→" to select channel "2";

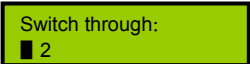

↓ 4. Press "MENU" to confirm.



Note:

☞ Select "All" standing for switch through all channels.

3. Close

Close one output channel or all output channels.

Example: Close output channel 2.

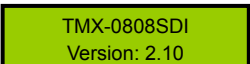

↓ 1. Press "MENU" and press "←/→" until "Close" prompts;



↓ 2. Press "MENU" to enter "Close" menu;



↓ 3. Press "←/→" to select channel "2";



↓ 4. Press "MENU" to confirm.



Note:

☞ Select "ALL" stands for closing all channels.

4. Save scene

Save current video signal to appointed scene. 10 scenes can be saved at most, each scene has a number, from 0 to 9.

Example: Save scene 3

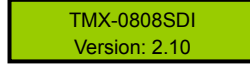

↓ 1. Press "MENU" and press "←/→" until "Save scene" prompts;

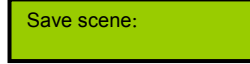

↓ 2. Press "MENU" to enter "Save scene";

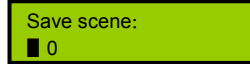

↓ 3. Press "←/→" to select scene number "3";

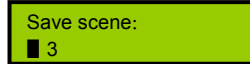

↓ 4. Press "MENU" to confirm.

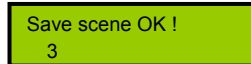

5. Recall scene

Recall video signal from selected scene.

Example: Recall scene 3

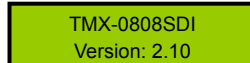

↓ 1. Press "MENU", and press "←/→" until "Recall scene" prompts;

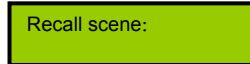

↓ 2. Press "MENU" to enter "Recall scene";

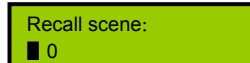

↓ 3. Press "←/→" select scene number "3";

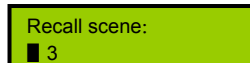

↓ 4. Press "MENU" to confirm.



6. Undo

Undo last switch operation.

TMX-0808SDI
Version: 2.10

1. Press "MENU", and press " \leftrightarrow " until "Undo" prompts;

Undo

2. Press "MENU" to execute.

Switch OK !

7. Demo Switch

Switches one by one all possible combinations from 1 → 1, 1 → 2, ..., 1 → 8, 2 → 1, 2 → 2, ..., 2 → 8, ..., 8 → 1, 8 → 2, ... to 8 → 8. The interval can be setup via setup menu (Refer to section 1.3.1).

TMX-0808SDI
Version: 2.10

1. Press "MENU" and press " \leftrightarrow " until "Demo switch" prompts;

Demo switch:

2. Press "MENU" to execute.

Demo switch:

8. Setting

Setup menu.

TMX-0808SDI
Version: 2.10

1. Press "MENU" and press " \leftrightarrow " until "Setting" prompts;

Setting

2. Press "MENU" to enter setup status. Refer to section 1.3.1 for details.

SyncSwitchDelay:
0 *ms

9. Status

Request corresponding state of input and output channels.

TMX-0808SDI
Version: 2.10

1. Press "MENU" and press " \leftrightarrow " until "Status" prompts;

Status

2. Press "MENU" to request corresponding status;

Video: 3 → :1

3. Press " \leftrightarrow " to request next status.

Video: 5 → :2

Chapter 2. IR Remote Control

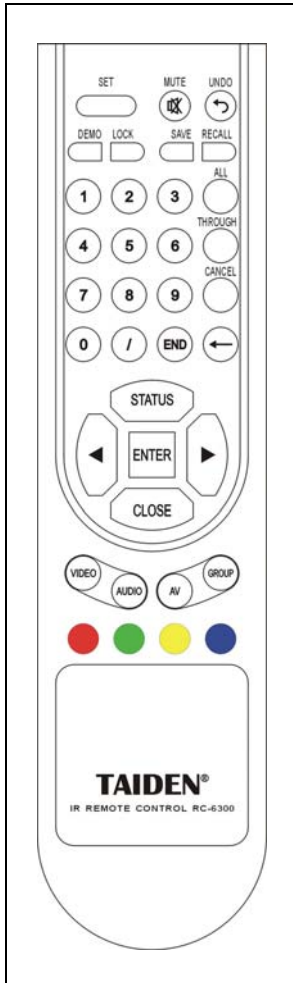

1. Basic function

Users can use remote control to operate matrixes, the function of remote control key is the same as matrix front panel key (Please refer to chapter 1 for detailed instructions).

Please refer to sections of menu operation for detailed operation method of remote control key.

2. Camera function

For the matrix with and has opened the video tracking function, users can use remote control to operate the cameras which connected to the matrix. The functions of camera operate as below:

1) Camera control

a. press the yellow button to enter the menu:

Camera Control
0

b. select a camera ID (1 to 8 buttons);

c. use the following buttons to adjust the camera;

Button	Function	Button	Function	Button	Function
◀	Left	STATUS	Up	Green	Magnify
▶	Right	CLOSE	Down	Red	Lessen

d. press the "CANCEL" button to exit.

2) Camera scan

a. press the blue button to enter the menu:

Camera Scan
0

b. select a camera ID (1 to 8 buttons);

c. use the following buttons to control the direction of the camera;

Button	Function	Button	Function
1	Frame scan (between preset 30 and 31)	2	Auto cruise
3	scan 300°	4	scan 180°

d. press the "CANCEL" button to exit.

The remote control can be used for all TAIDEN matrix main units with IR receipt function.

Chapter 3. Communication protocol and control code

This code system is used for controlling and operating TAIDEN professional Matrix Switchers by central control system or user programming software.

Protocol: Baud Rate: 9600; Data: 8 bits; Stop: 1 bit;
Parity Check Bit: No

Type	Code	Description
System Code	Lock;	Lock keyboard
	Unlock;	Unlock keyboard
	BeepOff;	Beep off
	BeepOn;	Beep on
	TAIDEN;	Select COM1 protocol to be TAIDEN;
	EXTRON;	Select COM1 protocol to be EXTRON;
	OTHER;	Select COM1 protocol to be OTHER;
Operation Code (TAIDEN)	If central control system does not execute switch within 15 s after input channel, TMX main unit cleans up channel automatically.	
	0xd9 0xe1 [x1] [x2]	Video of input channel [x1] switch to output channel [x2]. If input channel [x1] is 0, output channel [x2] will be closed.
	0xd9 0xe2 [x1] [x2]	Audio of input channel[x1] switch to output channel [x2]. If input channel [x1] is 0, the output channel [x2] will be closed.
	0xd9 0xe3 [x1] [x2]	Video and audio of input channel [x1] switch to output channel [x2]. If input channel is 0, the output channel [x2] will be closed.
	0xd9 0xe4 [x1] e9	Video of input channel [x1] switch to all output channels
	0xd9 0xe5 [x1] e9	Audio of input channel [x1] switch to all output channels
	0xd9 0xe6 [x1] e9	Video and audio of input channel [x1] switch to all output channels
	0xd9 0xec 0x01 0x00	Close all output channels
	0xd9 0xeb 0x03 0x00	Go through from all input channels to corresponding output channels
	0xd9 0xed 0x02 0x00	Execute switch
	0xd9 0xe7 0xe7 scene	Save corresponding relation to scene 0,1,2...9
	0xd9 0xe8 0xe8 scene	Recall scene XX
	0xd9 0xe9 0xe9 scene	Clear scene XX
	0xd9 0xc1 0xc1 0x00	Query the matrix type
	0xd9 0xc2 0xc2 0x00	Query the input status of all output channels
	0xd9 0xc4 [x1] 0x00	Query the input status of the output channel [x1]
Operation Code (OTHER)	[x1]All.	Input channel [x1] switch to all output channels
	All#.	Setup all channels one-to-one correspondence: 1->1, 2->2, 3->3...
	All\$.	Close all channels
	[x1]#.	Input channel [x1] switch to output channel [x1]
	[x1]\$.	Close output channel [x1]
	[x1]V[x2].	Video of input channel [x1] switch to output channel [x2]
	[x1]V[x2],[x3],[x4].	Video of input channel [x1] switch to output channel [x2], [x3], [x4]
	[x1]A[x2].	Audio of input channel [x1] switch to output channel [x2]
	[x1]A[x2],[x3],[x4].	Audio of input channel [x1] switch to output channel [x2],[x3],[x4]
	[x1]B[x2].	Video and audio of input channel [x1] switch to output channel [x2]
	[x1]B[x2],[x3],[x4].	Video and audio of input channel [x1] switch to output channel [x2],[x3],[x4]

	Save[X].	Save current status to scene [X]
	Recall[X].	Recall scene X]
	Clear[X].	Clear scene [X], status of all output channel are closed
	Type*.	Query the matrix type
	Status[x1].	Query the input status of the output channel [x1]
	Status.	Query the input status of all output channels
EXTRON:	[X1]*[X2]!	Video and audio of input channel [x1] switch to output channel [x2]
	[X1]*[X2]\$	Audio of input channel [x1] switch to output channel [x2]
	[X1]*[X2]%	Video of input channel [x1] switch to output channel [x2]
	[X1]*[X2]&	Input channel [x1] switch to output channel [x2]

Note:

- ☞ [x1], [x2], [x3], [x4] is channel number of input or output; only 1~8 available, otherwise regarded as error.
- ☞ “[and]” do not send code;
- ☞ End each command by code such as “.”, “,”.

Command examples:

1. System code: TAIDEN; EXTRON; OTHER;

For example: convert a TAIDEN code system unit to a EXTRON code system unit, run “EXTRON;”, then the unit will only support code ends with “!\$%&”.

2. [x1]All.

For example: Input channel 3 switch to all output channels, code is “3All.”.

3. All#.

Setup all channels one-to-one correspondence:
1->1, 2->2, 3->3...8->8.

4. All\$.

Close all output channels.

5. [x]#.

For example: Input channel 5 switch to output channel 5, code is “5#.”.

6. [x]\$.

For example: Close output channel 5, code is “5\$.”.

7. [x1]V[x2].

For example: Video of input channel 3 switch to output channel 5, code is “3V5.”. Video of input channel 3 switch to output channel 8, 9, 12, code is “3V8,9,12.”.

8. [x1]A[x2].

For example: Audio of input channel 10 switch to output channel 2, code is “10A2.”. Audio of input channel 10 switch to output channel 2, 5, 6, code is “10A2,5,6.”.

9. [x1]B[x2].

For example: Video and audio of input channel 1 switch to output channel 2, 3, 5, code is “1B2,3,5.”.

10. Save[x].

For example: Save current status to scene 7, code is “Save7.”.

11. Recall[x].

For example: Recall scene 5, code is “Recall5.”.

Chapter 4. Technical data

Spec. \ Type	TMX-0404SDI	TMX-0804SDI	TMX-0808SDI
Video			
Date rates	143 Mbps - 2.97 Gbps		
Date types	8 bit or 10 bit		
Video input			
Connectors	4 × BNC female	8 × BNC female	
Input cable equalization	Typical equalization cable length (Belden 1694A standard cable): 100 m @ 2.97 Gbps 200 m @ 1.485 Gbps 400 m @ 270 Mbps		
Input level	0.7 V - 1.2 Vp-p		
Nominal level	0.8 Vp-p		
Impedance	75 Ohm		
Return loss	20 dB - 30 dB @ 5 MHz to 1.5 GHz		
Video output			
Connectors	4 × BNC female		8 × BNC female
Nominal level	0.8 V±7%		
Output level	0.5 V - 1.6 Vp-p		
Impedance	75 Ohm		
Return loss	>15 dB @ 5 MHz to 1.5 GHz		
DC offset	± 100 mV with no offset at input		
Jitter	20 ps - 30 ps @ HD/3G rate 40 ps - 60 ps @ SD rate		
Rise and fall time (20~80%)	SD: 600 ps HD/3G: 100 ps		
Control			
Video track off:			
COM (RS-232)	RS-232, 9 pin female D connector		
COM1	Baudrate: 9600, data: 8 bits, stop: 1 bit, no parity		
RJ45	TCP/IP		
RS422/RS485/TAINET	Invalidation		
Video track on:			
COM (RS-232)	RS-232, 9 pin female D connector		
COM1	Baudrate: 9600, data: 8 bits, stop: 1 bit, no parity		
RJ45	Invalidation		
TAINET	Baudrate: 19200, to main unit		
RS422/RS485	Baudrate: 9600, to dome camera		

Type Spec.	TMX-0404SDI	TMX-0804SDI	TMX-0808SDI
General spec.			
Power supply	100 V AC - 240 V AC, 50/60 Hz		
Temperature	Operating: 0 °C to + 50 °C; storage: -20 °C to + 70 °C		
Humidity	Storage and operating: 10% to 90%		
Dimensions h × w × d (mm)	483×208×43 (1U high, full rack width)		
Weight	2.7 kg		
Mean time between failures	30, 000 hours		

TAIDEN INDUSTRIAL CO.,LTD.

Copyright by TAIDEN